



LUMCO[®]

ČESKÝ VÝROBCE
SEDACÍCH SOUPRAV



KARIN



LUKAS



NATALI



VIKI



DREAM



KRYŠTOF



ČESKÁ KVALITA – ČALOUNĚNÝ NÁBYTEK PRO VÁŠ DOMOV

Jsme tu s Vámi od roku 2004 a po sedmi letech jsme začali s vlastní výrobou čalouněného nábytku.

Pod značkou Lumco se skrývá široká nabídka kvalitního nábytku:
sedáčkové systémy, pohovky, křesla, taburety a související sortiment.

Každý kus nábytku je navržen s důrazem na detail a vyroben s cílem přinést nejen funkční, ale i krásný prvek do Vašeho domova. Kvalitní materiály a špičkové dílenské zpracování je předností výroby značky LUMCO.

Vyberte si z naší nabídky a objevte krásu českých výrobků, které vytváříme.

Navštivte naše webové stránky: www.lumco.cz.

Kontaktujte nás: odbyt@lumco.cz

 LUMCO nábytek

 sedaci_soupravy_lumco



SEDACÍ SOUPRAVY

6 ESTER



8 NATALI



10 NATALI MINI



11 KARIN SOFA



11 KLÁRA SOFA



12 KARIN



14 KLÁRA



16 OLIVIE



18 LEONA



20 JUDITA



21 DREAM



22 ADEL



23 KLAUDIE



24 JERRY



24 FILIP



25 DANIELA



25 ONDRA



26 LADA



KŘESLA

27 KRYŠTOF



27 JANNET



27 SIMON



27 VIKI



28 LUKAS



28 TIGRA



TABURETY

29



OSTATNÍ

26 USB PODRUČKA



31 KOSTKA, VAK



31 Klap MATRACE



VYBAVENÍ INTERIÉRŮ NA MÍRU

32



ESTER

područky (L+P)

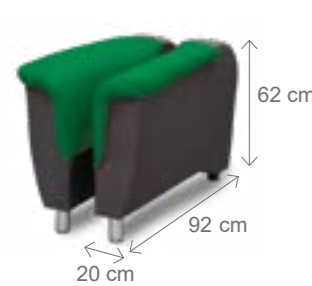

křeslo



I.



II. (L+P)



II.



II. ÚP

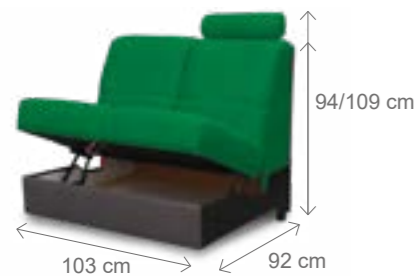

III. (L+P)



III.



III. ÚP

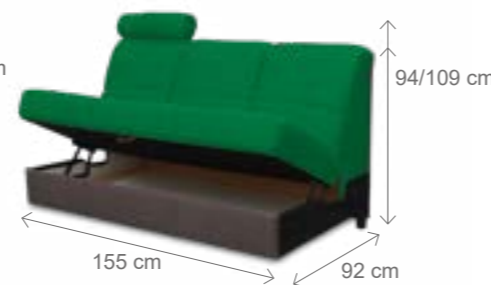

III. R



R - polohovací

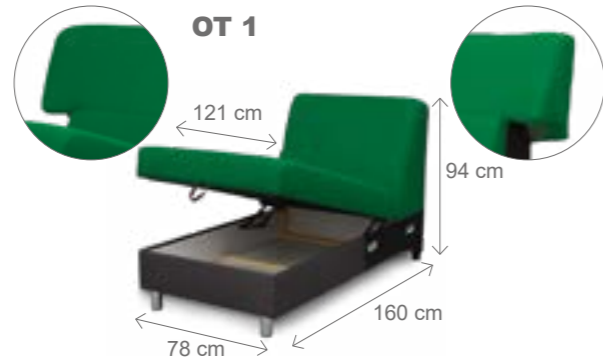

OT 1 — možnost jedné úpravy bez příplatku

Zkrácení na rozměr: 150 cm, 140 cm
 Prodloužení na rozměr: 170 cm, 180 cm, 190 cm, 200 cm
 Zúžení na rozměr: 68 cm, 58 cm



OT 2 — možnost jedné úpravy bez příplatku

Zkrácení na rozměr: 183 cm, 173 cm, 163 cm, 153 cm, 142 cm

Z technologických důvodů musí být díl III. R zakončen područkou.



Sedací souprava ESTER je určena na nosnost 110 kg, po domluvě lze použít PUR výplně sedáků na vyšší zátěž.

OT 1 (L) + III. R + R + II. ÚP (P)
 rozklad 284 x 122 cm

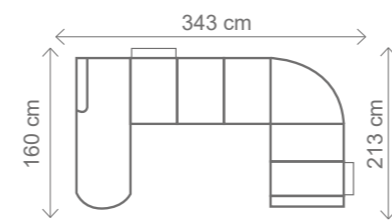

III. R (L) + OT 2 (P)
 rozklad 205 x 122 cm

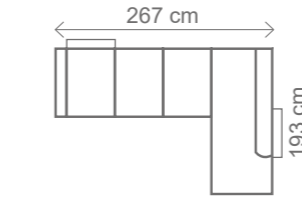

KŘESLO

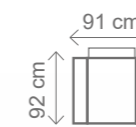

III. R (L) + R + II. ÚP (P)
 rozklad 202 x 122 cm

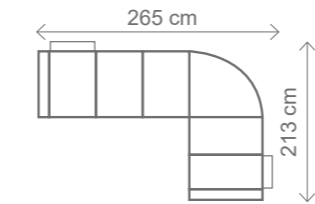

OT 1 (L) + III. R (P)
 rozklad 230 x 122 cm

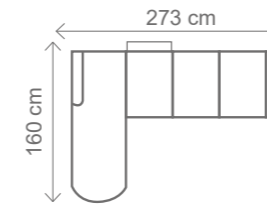

podhlavník ESTER

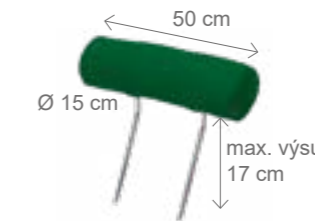

univerzální podhlavník

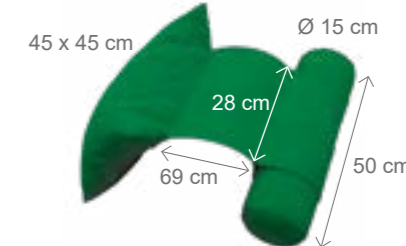

válec

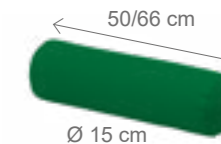

Možnost zvýšení sedu o 5 cm za příplatek.



NATALI

SEDACÍ SOUPRAVY

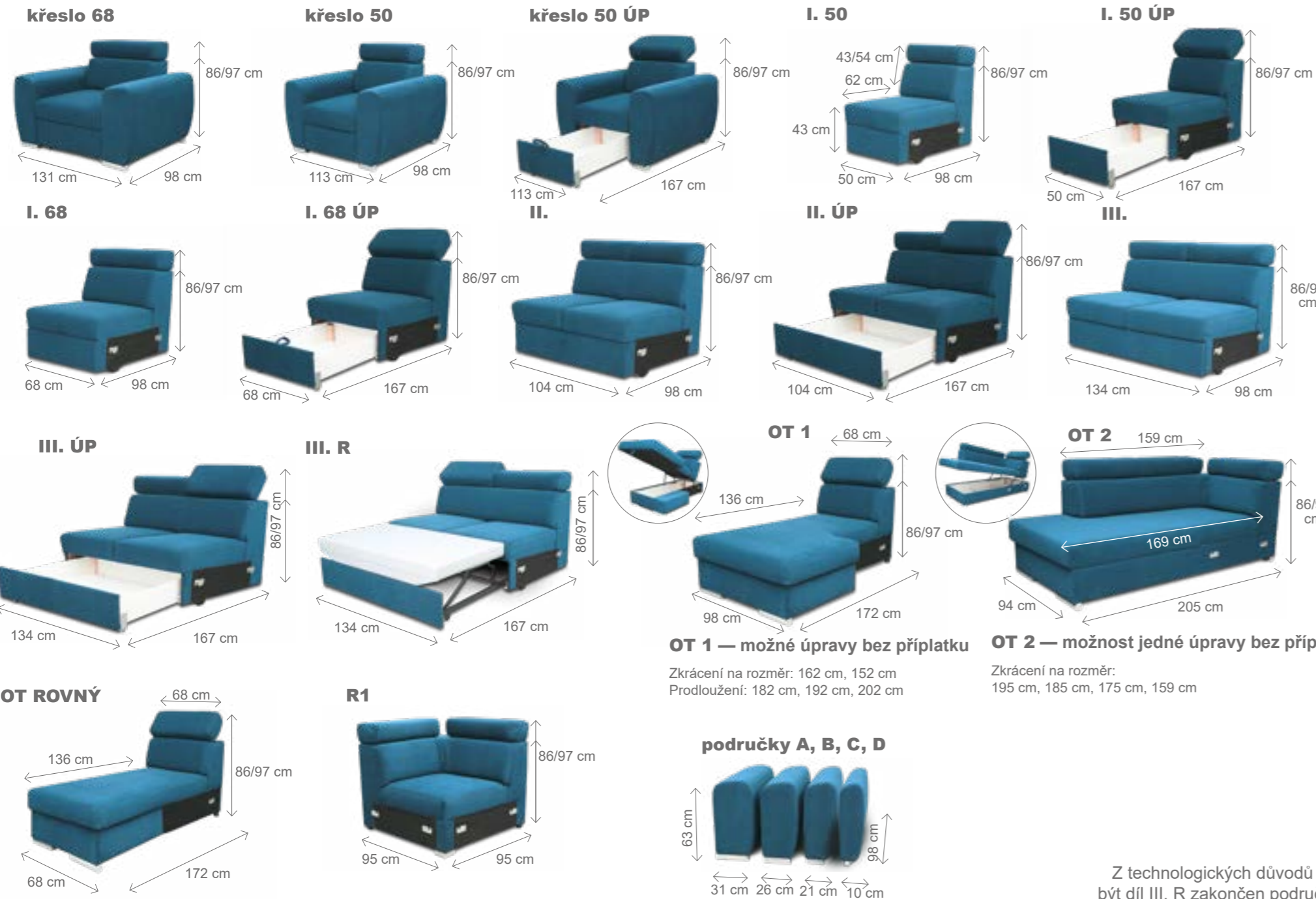

Sedací souprava NATALI je určena na nosnost 130 kg, po domluvě lze použít PUR výplně sedáků na vyšší zátěž.

OT1 (L) + III. R + R + II. ÚP (P) rozklad 265 x 131 cm
OT1 (L) + III. R + R + I. 50 ÚP (P) rozklad 202 x 131 cm

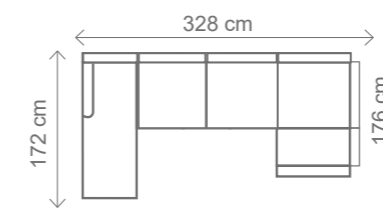
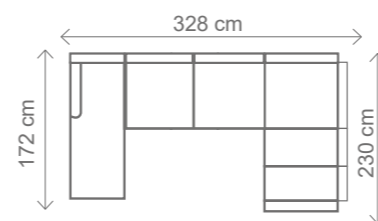

III. R (L) + R + II. ÚP (P) rozklad 191 x 131 cm

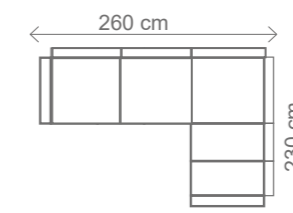

OT1 (L) + III. R (P) rozklad 202 x 131 cm

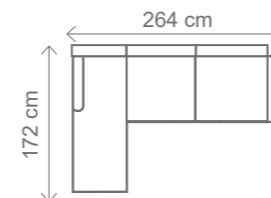

OT2 (L) + III. R (P) rozklad 191 x 131 cm

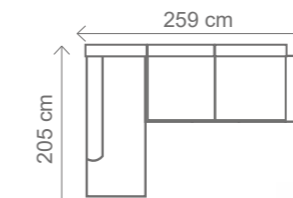

Možnost zvýšení sedu o 5 cm za příplatek.

Rozměry se standardními područkami (A).

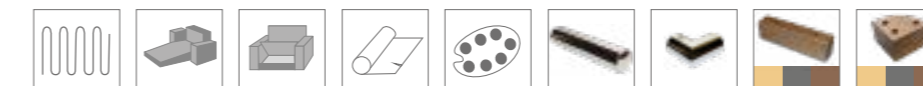

OT 1 — možné úpravy bez příplatku
 Zkrácení na rozměr: 162 cm, 152 cm
 Prodloužení: 182 cm, 192 cm, 202 cm

OT 2 — možnost jedné úpravy bez příplatku
 Zkrácení na rozměr:
 195 cm, 185 cm, 175 cm, 159 cm

Z technologických důvodů musí být díl III. R zakončen područkou.



NATALI MINI

III. R (LD) + OT ROVNÝ (PD)
rozklad 202 x 131 cm

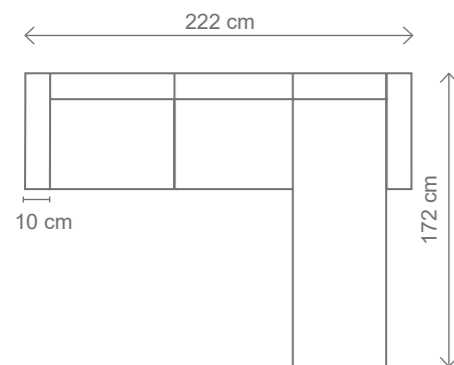

Možnost zvýšení sedu o 5 cm za příplatek.

KARIN SOFA

Rozklad pro příležitostné spaní

KARIN III. SOFA
rozklad 197 x 140 cm

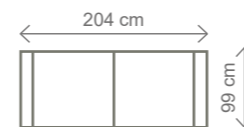

KLÁRA SOFA

Rozklad pro příležitostné spaní

KLÁRA III. SOFA
rozklad 197 x 140 cm



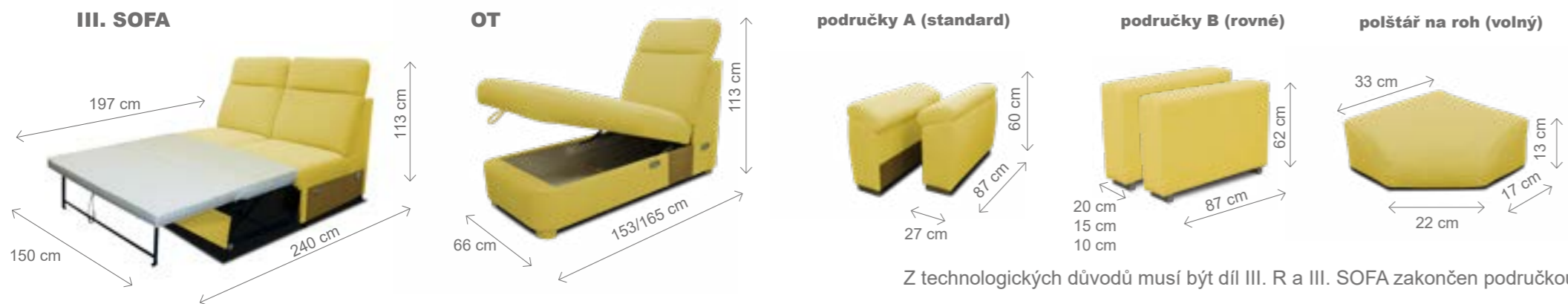

OT — možnost jedné úpravy bez příplatku
 Prodloužení na rozměr: 180 cm, 195 cm

Z technologických důvodů musí být díl III. R a III. SOFA zakončen područkou.
 Rozměry se mohou měnit v závislosti na poloze/sklopení záhlavníku. Relaxační polohovatelné záhlavníky mají 6 volitelných poloh. Možnost odmontování záhlavníků kvůli stěhování (u R a I). Nabízíme výběr ze dvou druhů područek: A (standard) a B (rovné) jako u sedací soupravy Kláry. Sedací souprava má ocalouněná záda v barvě potahu.



Sedací souprava KARIN je určena na nosnost 110 kg, po domluvě lze použít PUR výplně sedáků na vyšší zátěž.

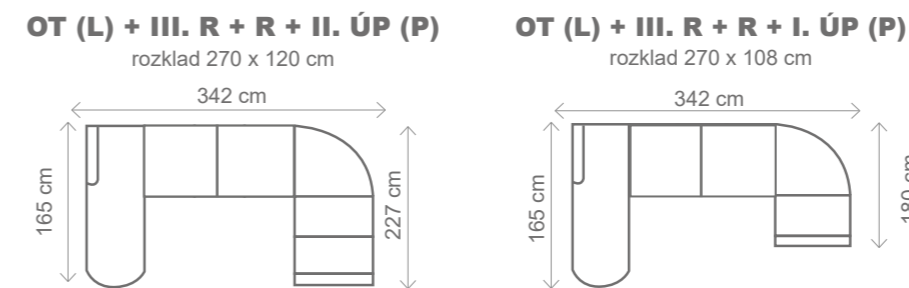
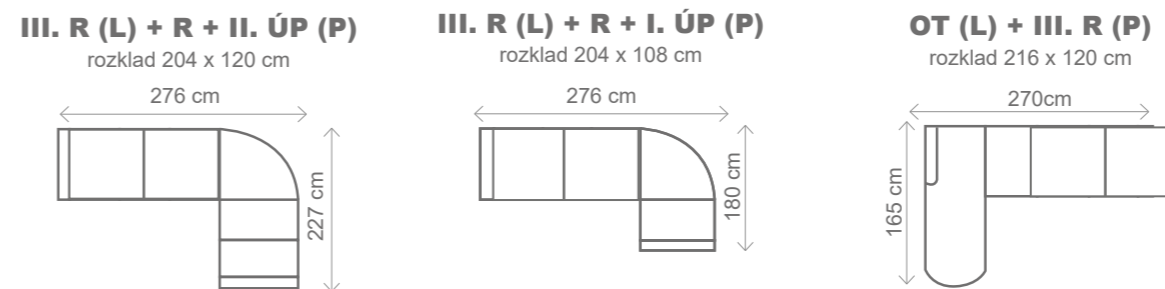

Rozměry se standardními područkami (A).



křeslo



I.



I. ÚP



II. (L+P)



II.



III. ÚP (L+P)



II. ÚP (L+P)



II. ÚP



III. (L+P)



III.



III. ÚP



III. R



III. SOFA



OT



OT
možnost jedné úpravy bez příplatku
Prodloužení: 168 cm, 183 cm

R



područky A (standard)



područky B (rovné)

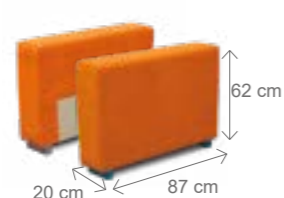

taburet KLÁRA ÚP



taburet KLÁRA zakončovací bez ÚP



Z technologických důvodů musí být díl III. R a III. SOFA zakončen područkou.



Sedací souprava KLÁRA je určena na nosnost 110 kg, po domluvě lze použít PUR výplně sedáků na vyšší zátěž.

OT (L) + III. R + R + II. ÚP (P)
rozklad 270 x 120 cm

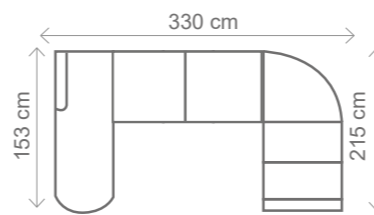

OT (L) + III. R + R + I. ÚP (P)
rozklad 270 x 108 cm

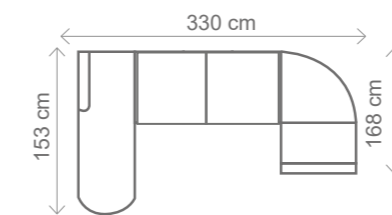

III. R (L) + R + II. ÚP (P)
rozklad 204 x 120 cm

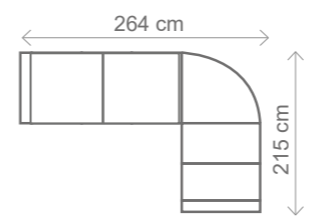

III. R (L) + R + I. ÚP (P)
rozklad 204 x 108 cm

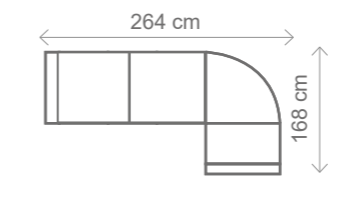

OT (L) + III. R (P)
rozklad 216 x 120 cm

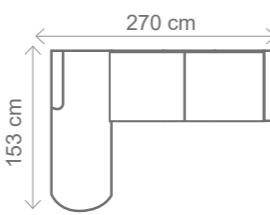

Rozměry se standardními područkami (A).



područky A (standard)



područky B (rovné)



OLIVIE

křeslo



I. 55



I. 55 ÚP



I. 70



I. 70 ÚP



Sedací souprava OLIVIE je určena na nosnost 110 kg, po domluvě lze použít PUR výplně sedáků na vyšší zátěž..



II.



II. ÚP



II. R



III. R



III. ÚP



OT (L) + III. R + R + II. ÚP (P)
rozklad 270 x 123 cm

OT (L) + III. R + R + I. 55 ÚP (P)
rozklad 270 x 113 cm

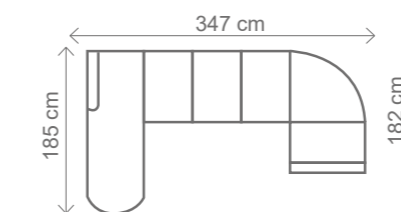
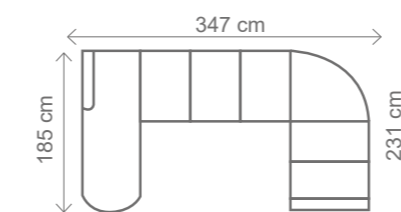

OT



III.



R



R I.



R IV.



III. R (L) + R + II. ÚP (P)
rozklad 205 x 123 cm

III. R (L) + R + I. 55 ÚP (P)
rozklad 205 x 113 cm

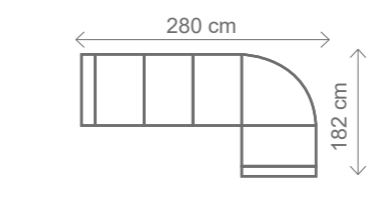
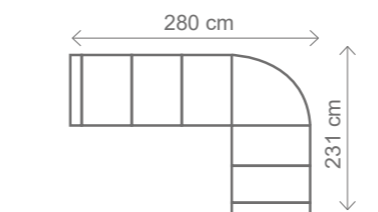

OT (L) + III. R (P)
rozklad 215 x 123 cm

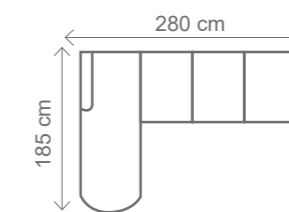

taburet půlkruh bez ÚP



područky (L+P)



taburet OLIVIE bez ÚP



podhlavník Olivie

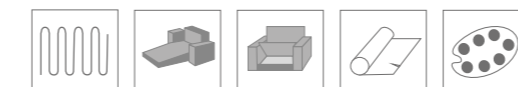

LEONA

křeslo



I. 55



I. 55 ÚP



I. 70



I. 70 ÚP



II.



II. ÚP



II. R



III. (L+P)



III. ÚP



Sedací souprava LEONA je určena na nosnost 110 kg, po domluvě lze použít PUR výplně sedáků na vyšší zátěž.

OT (L) + III. R + R + II. ÚP (P)
rozklad 260 x 118 cm

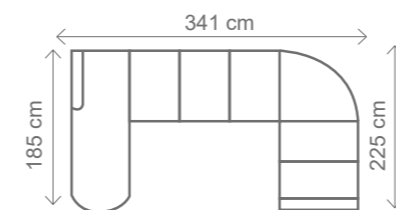

OT (L) + III. R + R + I. 55 ÚP (P)
rozklad 260 x 100 cm

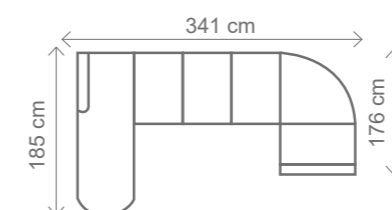

OT (L) + III. R (P)
rozklad 206 x 118 cm

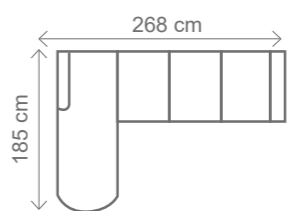

OT



III. R



R

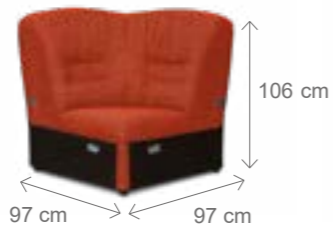

R I.

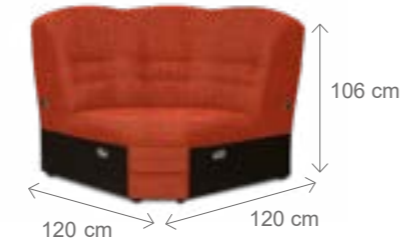

područky (L+P)



III. R (L) + R + II. ÚP (P)
rozklad 196 x 118 cm

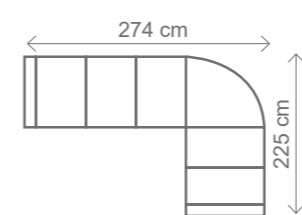

III. R (L) + R + I. 55 ÚP (P)
rozklad 196 x 100 cm

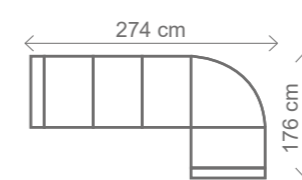

II. (L+P)



III. (L+P)



taburet MONA s ÚP



křeslo

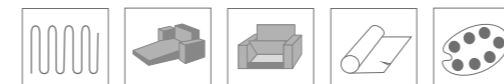

JUDITA

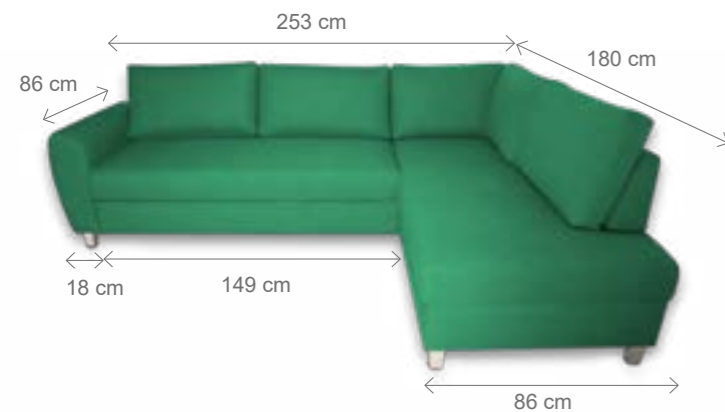

III. R (L) + OT2 (P)
rozklad 132 x 218 cm

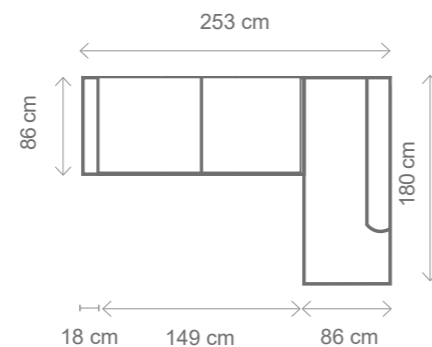

podhlavník

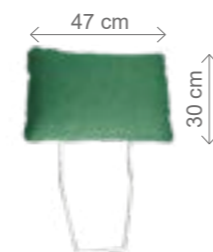

taštičkové pružiny



ROZMĚRY (cm) – nohy 9 cm

výška	délka	hloubka	hloubka sedu	spací plocha	výška sedu	výška opěry od sedu
87	253	180	54	132 x 218	44	53

ROZMĚRY (cm) – nohy 12 cm

výška	délka	hloubka	hloubka sedu	spací plocha	výška sedu	výška opěry od sedu
90	253	180	54	132 x 218	47	53

Každá sestava z technologických důvodů musí být zakončena područkou.

Sedací souprava JUDITA je určena na nosnost 110 kg, po domluvě lze použít PUR výplně sedáků na vyšší zátěž.

DREAM



OT (L) + III. SOFA (P)

III. SOFA (L+P)

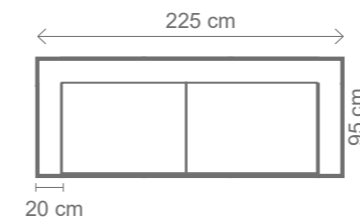

OT (L) + III. SOFA (P)

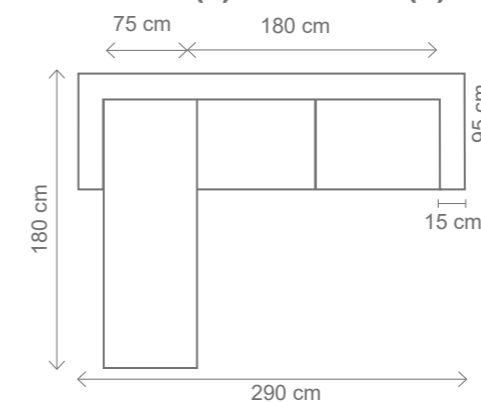

podhlavník



Matrace výška 14 cm.

Možnost područek o šířce 10 cm, 15 cm, 20 cm.

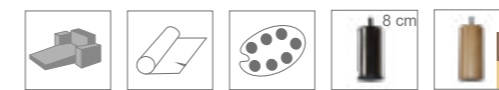

ROZMĚRY (cm) područky šíře 15 cm

výška	délka	hloubka	výška od země k lůžku	lůžko	výška sedu	hloubka sedu	výška opěry od sedu
105	290	180	56	187x160x14	48,5	47	53

Sedací souprava DREAM je určena na nosnost 110 kg, po domluvě lze použít PUR výplně sedáků na vyšší zátěž.

ADEL



Sedací souprava ADEL je určena na nosnost 110 kg, po domluvě lze použít PUR výplně sedáků na vyšší zátěž.

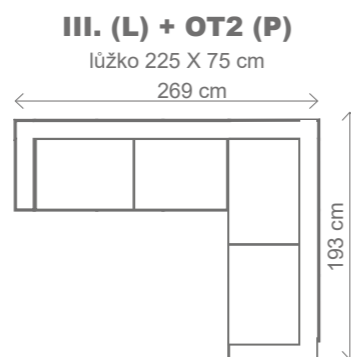
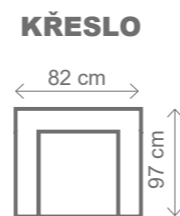
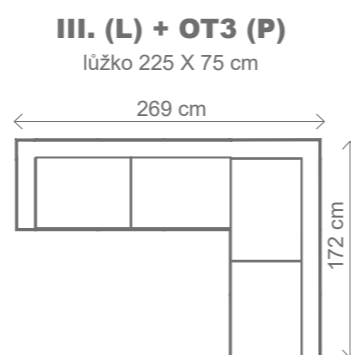
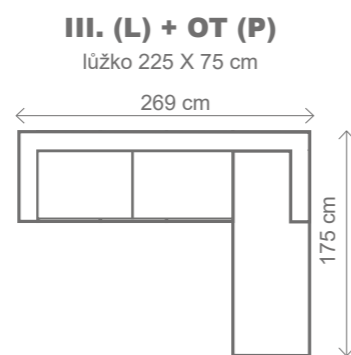
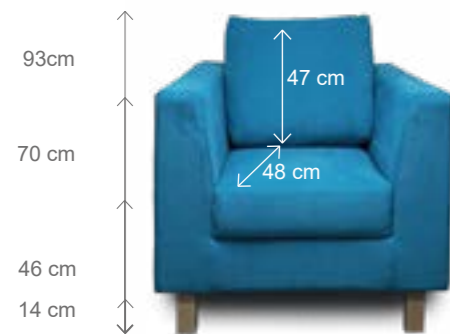

KLAUDIE



Sedací souprava KLAUDIE je určena na nosnost 110 kg, po domluvě lze použít PUR výplně sedáků na vyšší zátěž. Každá sestava z technologických důvodů musí být zakončena područkou.

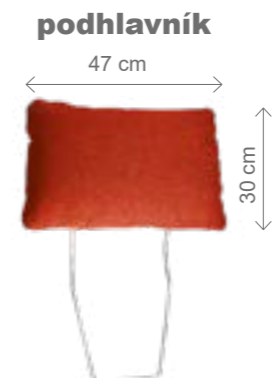
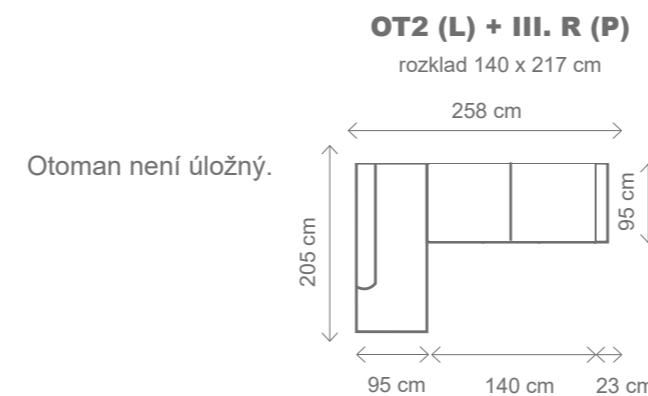

ROZMĚRY (cm)

výška	délka	hloubka	rozklad	v. sedu	hl. sedu	v. opěry od sedu
80	258	205	140 X 217	41	60	43

JERRY



ROZMĚRY (cm)

výška	délka	hloubka	rozklad	výška sedu	hloubka sedu	výška opěry od sedu
85	166	84	118 x 185	43	58	52

Pohovka JERRY je určena na nosnost 110 kg, po domluvě lze použít PUR výplně sedáků na vyšší zátěž.



FILIP



ROZMĚRY (cm)

výška	délka	hloubka	rozklad	výška sedu	hloubka sedu	výška opěry od sedu
91	265	172	202 x 131	43	62	50

Sedací souprava FILIP je určena na nosnost 130 kg, po domluvě lze použít PUR výplně sedáků na vyšší zátěž.



DANIELA

Pohovky pro každodenní spaní.



ROZMĚRY (cm)

výška	délka	hloubka	rozklad	výška sedu	hloubka sedu	výška opěry od sedu
84	207	103	200 x 160	44	53/83	38/52



Pohovka DANIELA je určena na nosnost 110 kg, po domluvě lze použít PUR výplně sedáků na vyšší zátěž.

ONDRA



ROZMĚRY (cm)

výška	délka	hloubka	rozklad	výška sedu	hloubka sedu	výška opěry od sedu
84	200	100	200 x 160	44	50/80	38/52

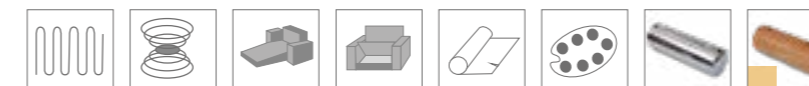

Pohovka ONDRA je určena na nosnost 110 kg, po domluvě lze použít PUR výplně sedáků na vyšší zátěž.

ČESKÝ VÝROBCE SEDACÍCH SOUPRAV

Pohovka pro každodenní spaní.

LADA



ROZMĚRY (cm)

výška	délka	hloubka	rozklad	výška sedu	hloubka sedu	výška opěry od sedu
100	258	160	215 x 130	46	55/71	58

Sedací souprava LADA je určena na nosnost 110 kg, po domluvě lze použít PUR výplně sedáků na vyšší zátěž.



KRYŠTOF



taburet KOLUMBUS

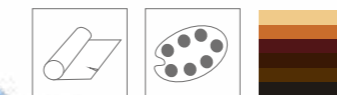

ZVÝŠENÁ VERZE

KRYŠTOF II.

ROZMĚRY KRYŠTOF II. (cm)

výš.	dél.	hl.	v. sedu	hl. sedu	v. opěry
119	74	89	49	49	77

KOLUMBUS II.

ROZMĚRY KOLUMBUS II. (cm)

výš.	dél.	hl.
49	60	45

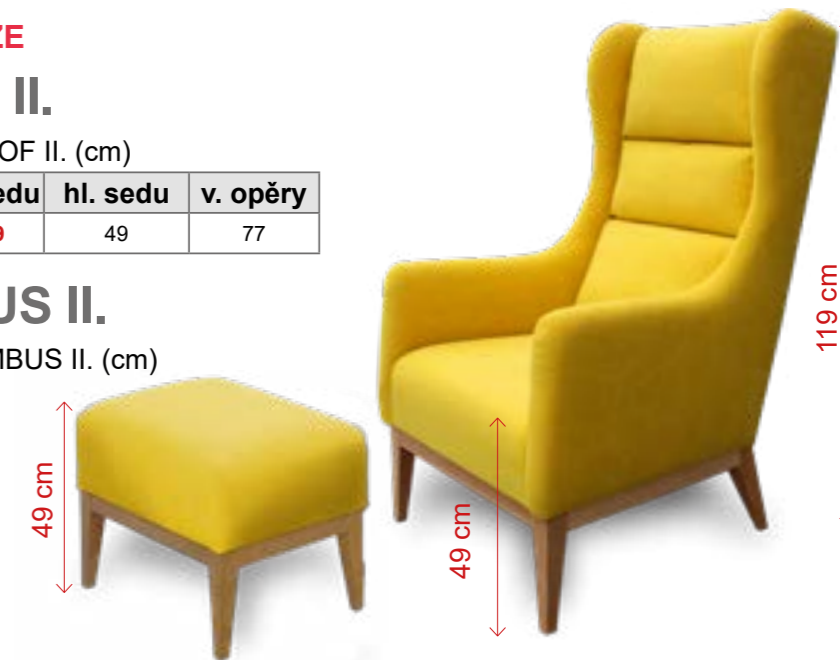

KŘESLA

USB PODRUČKA

USB nabíjecí jednotka do područky u sedací soupravy NATALI, KARIN, KLÁRA a ESTER.

Umístění jedné vestavěné nerezové nabíjecí jednotky USB A+C 5V do pravé nebo levé područky sedací soupravy LUMCO dle výběru zákazníka.

NATALI



USB



KLÁRA



ESTER



KARIN



SIMON

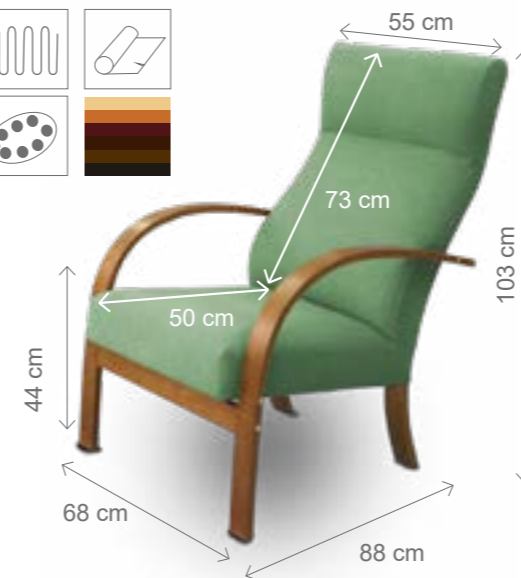
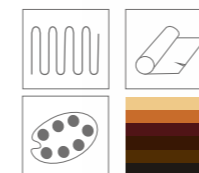

JANETT

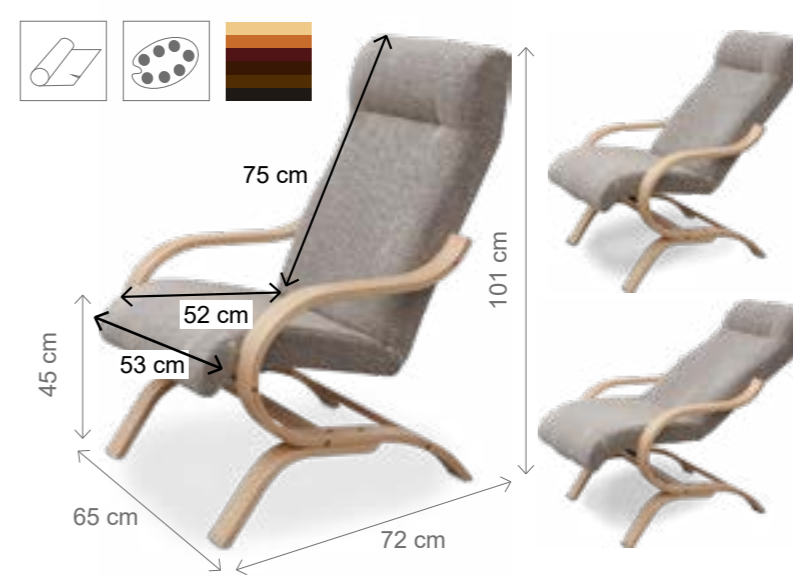
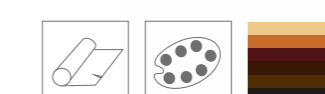

VIKI

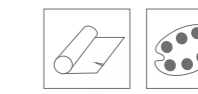

LUKAS I



ROZMĚRY LUKAS (cm) NOHY (14 cm)

	Výš.	Dél.	Hl.	Výš. sedu	Hl. sedu	Výš. opěrky
Lukas I	108	86	85	47	52	67
Lukas II (s bederním prošitím)	108	86	85	47	52	67
Lukas III	118	86	85	47	52	77
Lukas IV (s bederním prošitím)	118	86	85	47	52	77

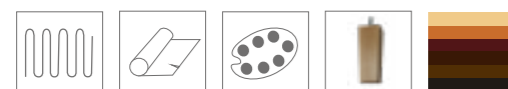

LUKAS II

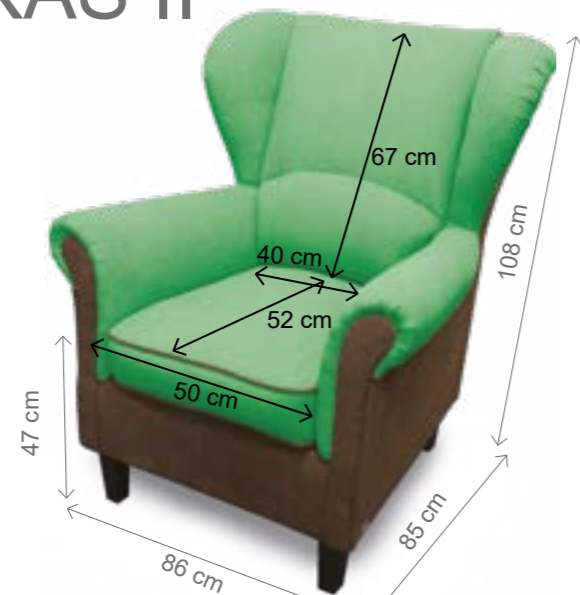

měkký sedák a opěrák

TIGRA

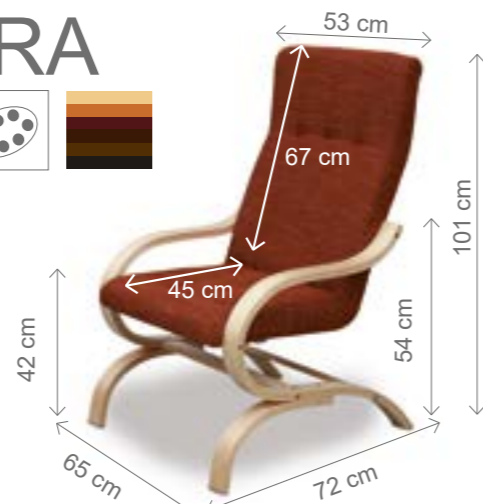
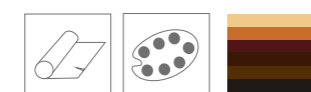

(křížové područky)

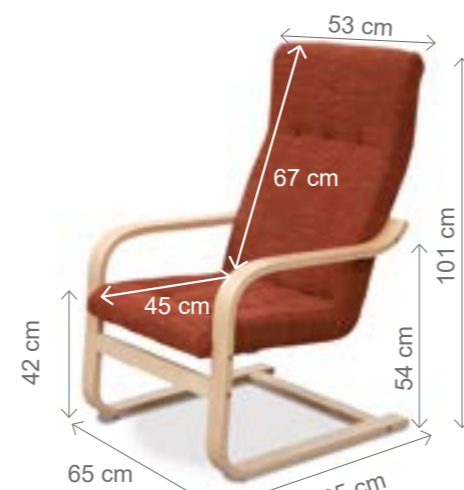

(rovné područky)

LUKAS taburet



ADRIANA

s ÚP s prošíváním



KARIN

s ÚP

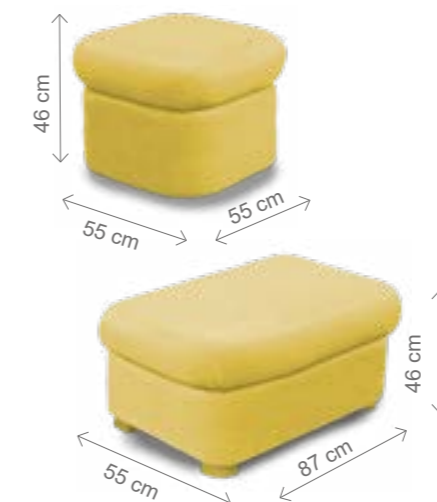

taburet 80 x 50 cm
taburet 60 x 40 cm
s ÚP

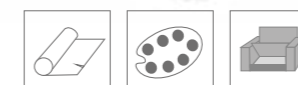

NATALI

bez ÚP

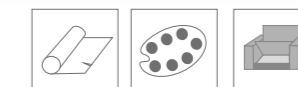
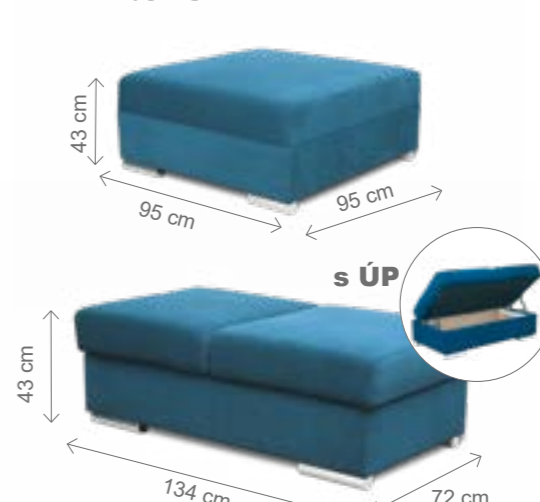

taburet 50 x 50 cm
taburet 60 x 60 cm
s ÚP

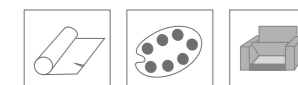
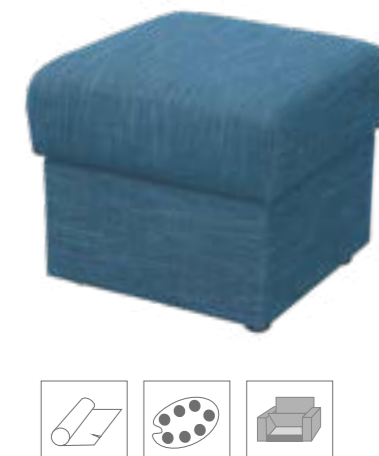

KLÁRA

s ÚP

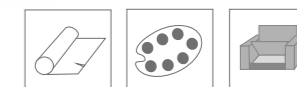

taburet KLÁRA
zakončovací bez ÚP

VIKI

bez ÚP

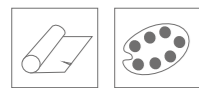

MONA

s ÚP

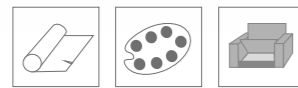

PUK

bez ÚP

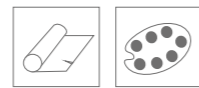

ZORA

bez ÚP

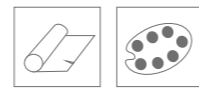
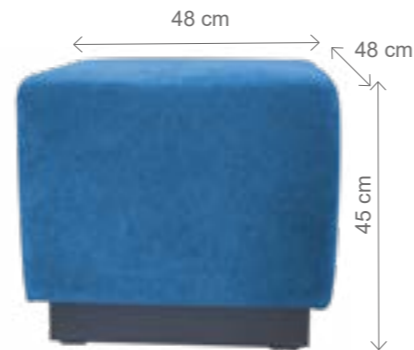

KOSTKA



KLAP matrace

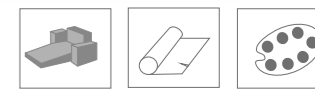

ROZMĚRY (cm)

	výška	délka	hloubka
rozložená/matrace	9	190	70
složená/taburet	28	63	70

OLIVIE

podhlavník univerzální



bez ÚP

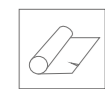

bez ÚP

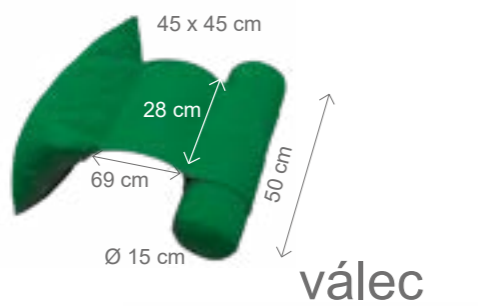

válec



NELA
polštář



polštáře



VAK KLOKAN

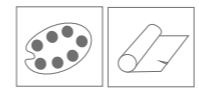

ROZMĚRY (cm)

výška	délka	hloubka	objem	nosnost
86/105	86	70	200 l	120 kg

podložka pro mazlíčky



ROZMĚRY (cm)	
A	B
77x97	58x58

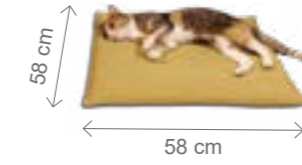
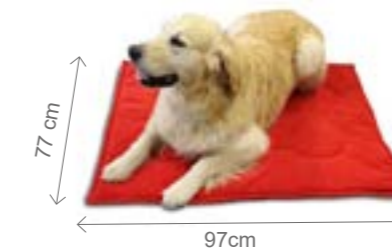

LUMÍK

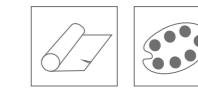
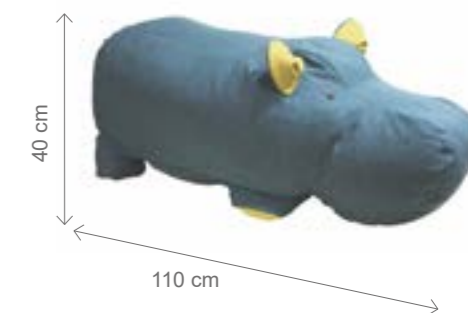

VYBAVENÍ INTERIÉRŮ NA MÍRU

Nabízíme kompletní i částečnou realizaci prostor nábytkem na míru.
 Vybavení prostor hotelů, restaurací, kaváren, kanceláří, dětských pokojů,...





ČALOUNĚNÉ POSTELE



SEDACÍ SOUPRAVY podle vlastního návrhu



Více informací o realizacích interiérů naleznete na stránkách www.lumco.cz

Barevný vzorník dřeva

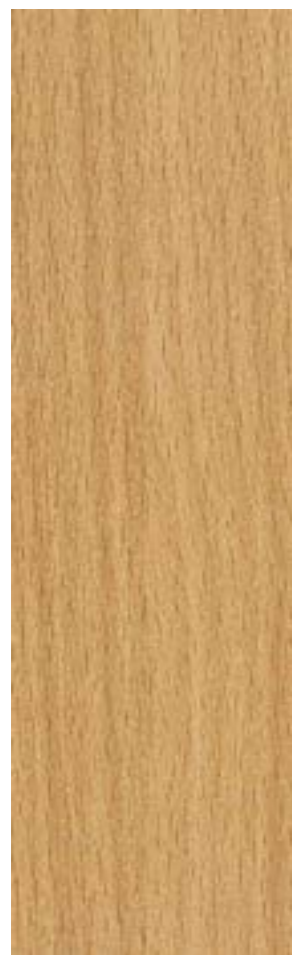

Buk

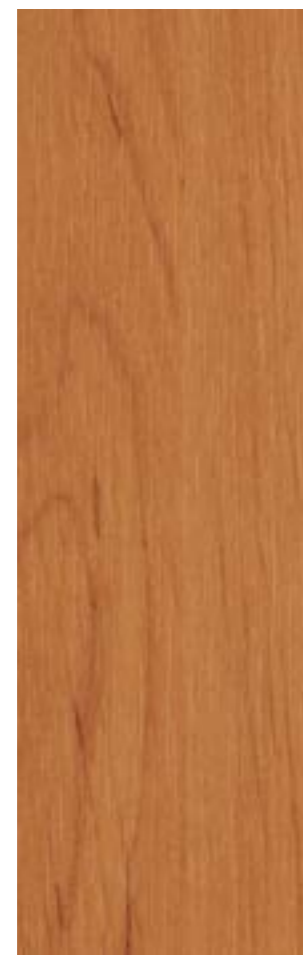

Olše



Mahagon



Rustikal





















Ořech



Wenge

Barvy jsou přibližné - mírná barevná odlišnost je možná.

VYSVĚTLIVKY

				
	křeslo	armchair	Sessel	fauteuil
I.	1-sed bez funkce	1-place without function	1-er Sofa ohne Funktion	monoplace sans fonction
I. ÚP	1-sed s úložným prostorem	1-place with storage space	1-er Sofa mit dem Laderaum	monoplace à espace de stockage
II.	2-sed bez funkce	2-places without function	2-er Sofa ohne Funktion	à siège double sans fonction
II. (L+P)	2-sed bez funkce s levou + pravou područkou	2-places without function with left and right armrest	2-er Sofa ohne Funktion mit der linken und rechten Armlehne	à siège double sans fonction à accouder gauche + droit
II. ÚP	2-sed s úložným prostorem	2-places with storage space	2-er Sofa mit dem Laderaum	à siège double à espace de stockage
II. ÚP (L+P)	2-sed s úložným prostorem s levou + pravou područkou	2-places with storage space with left and right armrest	2-er Sofa mit dem Laderaum mit der linken und rechten Armlehne	à siège double à espace de stockage à accouder gauche + droit
II. R	2-sed s rozkladem	2-places with function of enlargement	2-er Sofa mit der Zerlegung	à siège double à décomposition
II. SOFA	2-sed s lehátkem	2-places with folding bed	2-er Sofa mit der Liege	à siège double à chaise longue
III.	3-sed bez funkce	3-places without function	3-er Sofa ohne Funktion	à siege triple sans fonction
III. (L+P)	3-sed bez funkce s levou + pravou područkou	3-places without function with left and right armrest	3-er Sofa ohne Funktion mit der linken und rechten Armlehne	à siege triple sans fonction à accouder gauche + droit
III. ÚP	3-sed s úložným prostorem	3-places with storage space	3-er Sofa mit dem Laderaum	à siege triple à espace de stockage
III. ÚP (L+P)	3-sed s úložným prostorem s levou + pravou područkou	3-places with storage space with left and right armrest	3-er Sofa mit dem Laderaum mit der linken und rechten Armlehne	à siege triple à espace de stockage à accouder gauche + droit
III. R	3-sed s rozkladem	3-places with function of enlargement	3-er Sofa mit der Zerlegung	à siege triple à décomposition
III. SOFA	3-sed s lehátkem	3-places with folding bed	3-er Sofa mit der Liege	à siege triple à chaise longue
OT	otoman	divan	Ottomane	divan
R	roh	corner	Ecke	coin
	taštičková pružina	pocket spring	taschenfederkern	ressort ensaché
	vlnitá pružina	corrugated spring	wellige Feder	ressort onduleux
	bonnell pružina	bonnell spring	bonnel Feder	ressort bonnel
	rozklad	function of enlargement	Zerlegung	décomposition
	úložný prostor	storage space	Laderaum	espace de stockage
	látka	textile fabric	Stoff	étoffe
	barevná škála	color range	Auswahl an den Farben	gamme de couleurs
	chromovaná nožička	chromium foot	das Chrombeinchen	pied chromique
	dřevěná nožička	wooden foot	das Holzbeinchen	pied de bois
	buk	beech	büchen	hêtre
	olše	alder	erle	aulne
	mahagon	mahogany	mahagoni	acajou
	rustikal	rustical	rustikal	rustique
	ořech	walnut	nussbraun	noyer
	wenge	wenge	wenge	wenge

Tolerance rozměru: ±3%. Výrobce si vyhrazuje právo konstrukčních změn u nabízených modelů nábytku beze změny jejich obecného charakteru. Obrázky jsou ilustrační a mohou se od reálných barevně lišit. Za tiskové chyby neručíme.

VRSTVENÍ SEDACÍ SOUPRAVY

1. kostra
2. filc
3. polyuretanová pěna
4. rouno z dutého vlákna
5. potahový materiál



Öko-Tex Standard 100 je mezinárodní testovací a certifikační systém pro textilie, vyráběné pouze ze zdravotně nezávadných materiálů. Byl vyvinut v roce 1992.

TECHNOLOGIE ÚPRAVY POTAHOVÉ LÁTKY



Užívejte si více života ... protože AQUACLEAN myslí na vás. Díky inovativní technologii si můžete užívat života a nedělat si starosti s případnými skvrnami, které se mohou den co den objevit na vaší pohovce.



Aquaclean je pokročilá ochrana vaší čalouněné sedačky. Tato úprava pokrývá jednotlivá vlákna neviditelnou molekulární vrstvou, která zabrání proniknutí nečistot do látky.
www.aquaclean.com



Technologie Aquaclean je revoluční povrchová úprava, která umožňuje odstranit skvrny pouze pomocí vody. Údržba je velmi jednoduchá a skvrny odstraní za minimum času.



Aquaclean umožňuje snadné odstranění většiny skvrn vzniklých v domácnosti (víno, inkoust, omáčky, tuk, bláto, čokoláda, krém aj), usnadní vám tak život a vy získáte více času na důležité věci.

Jsme hrdými členy...



Garantováno...



Naše firma získala významné ocenění a to druhé místo v soutěži Vodafone Firma roku 2017 Královéhradeckého kraje



Ocenění nazvané Firma roku Náchodská 2016 zorganizovala Krajská hospodářská komora Královéhradeckého kraje, oblast Náchod. Druhým rokem byly oceněny významné regionální firmy.





LUMCO spol. s r.o.

Maloskalická 68
Česká Skalice
552 03

Česká republika

Tel.: +420 491 420 473
Mob.: +420 739 043 340

E-mail: odbyt@lumco.cz

www.lumco.cz